

**DETAIL A  
SCALE 1 : 5**

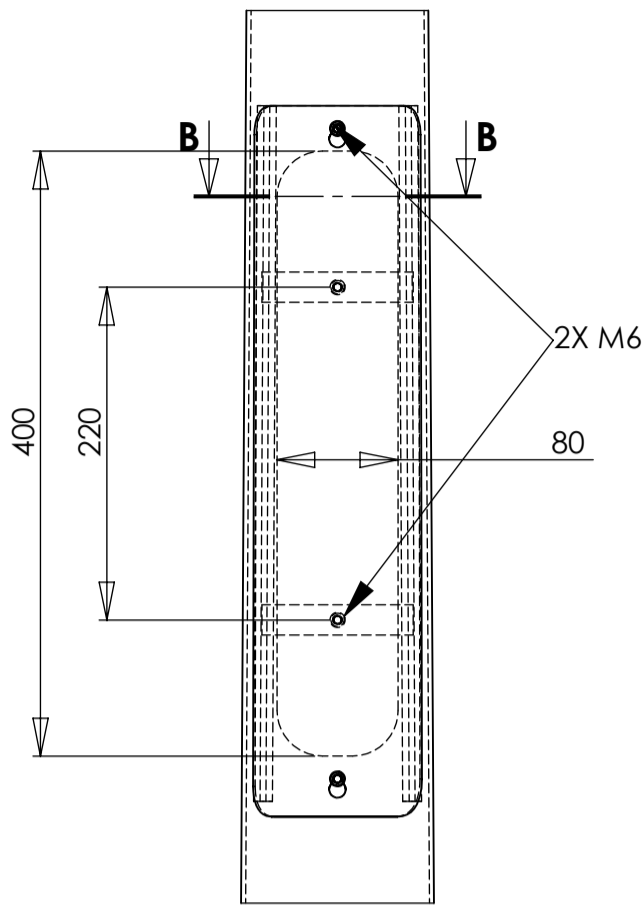

**SECTION B-B  
SCALE 1 : 5**

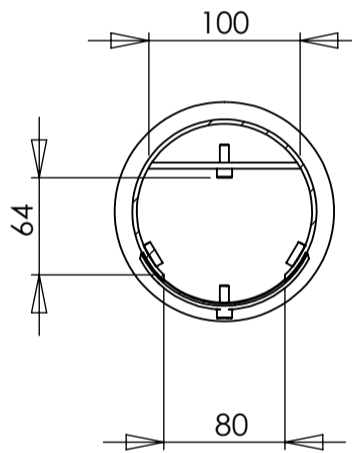

**DETAIL C  
SCALE 1 : 5**

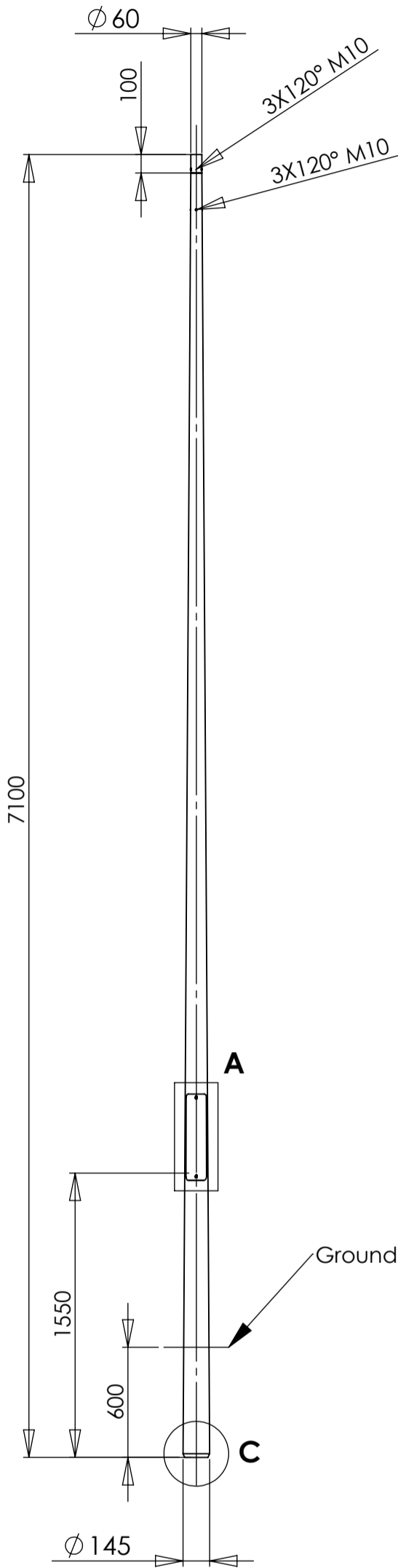
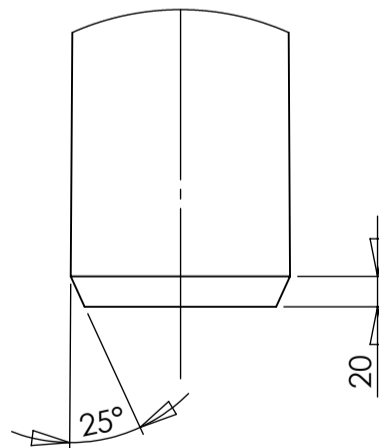

Raw Material = 52.66 kg  
Area : 2,38 m<sup>2</sup>

REV	CREATED BY	DATE	DESCRIPTION	APPROVED BY	DATE
0	ta.maatta	3.5.2022	CREATE A LAYOUT	jo.innanen	3.5.2022
			Nikkarintie 4 FI-51200 Kangasniemi Finland Tel +358 15 337 7770 www.tehomet.com	THIS DRAWING IS PROPERTY OF VALMONT INDUSTRIES AND MUST NOT BE USED, COPIED OR PRODUCED WITHOUT VALMONT'S WRITTEN CONSENT	
MATERIAL :		CUSTOMER :		CALCULATION NUMBER :	PART NUMBER :
FINISH : GALV EN ISO 1461		B108K 4607929 KARTIORUNKO		DRAWING NUMBER :	REVISION
GENERAL TOLERANCE ± : EN40			A3	SCALE 1:30	100200KXXX B108K

SHEET :  
1/1

1