

**SECTION F-F
SCALE 1 : 20**

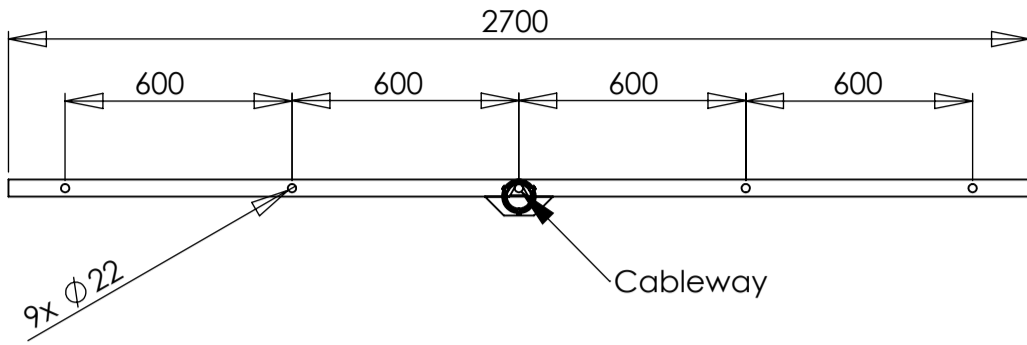

**DETAIL D
SCALE 1 : 10**

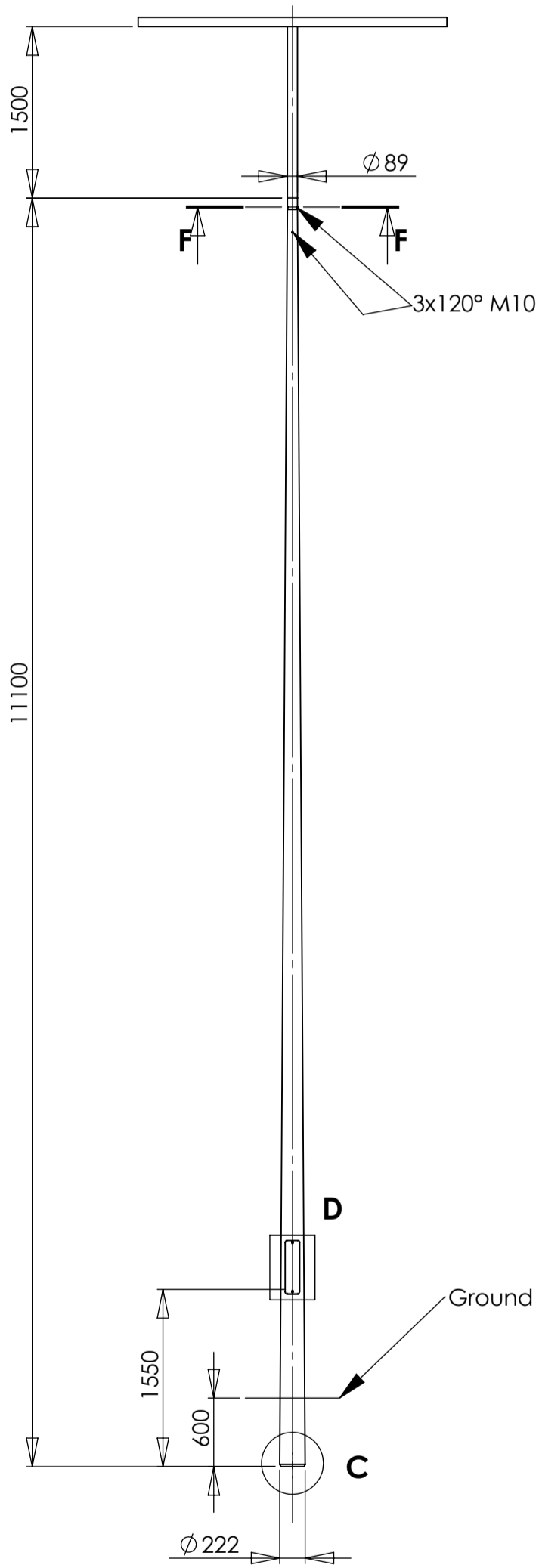
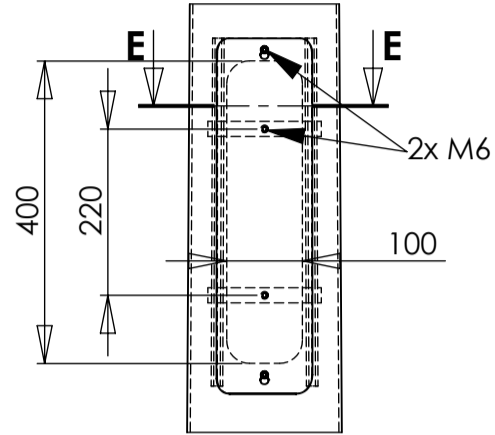

**SECTION E-E
SCALE 1 : 10**

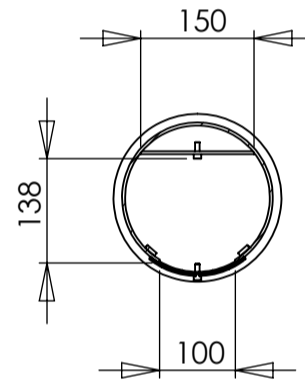

**DETAIL C
SCALE 1 : 10**

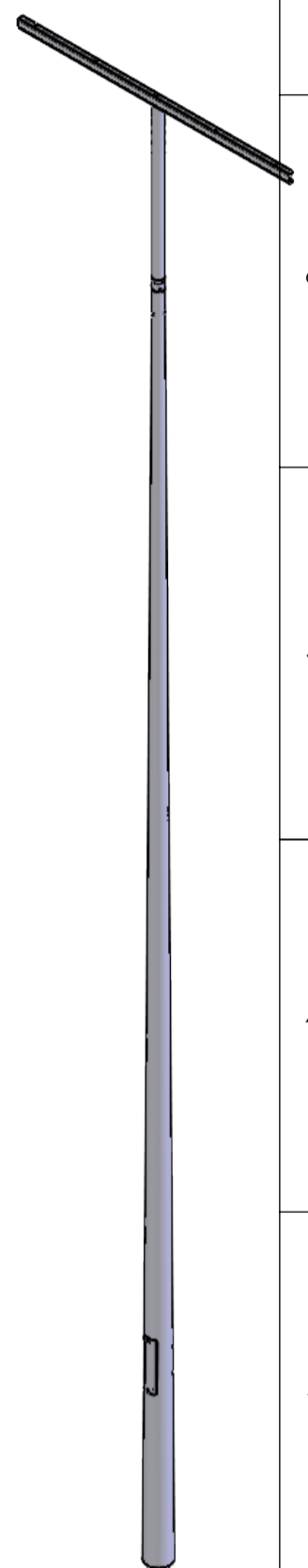
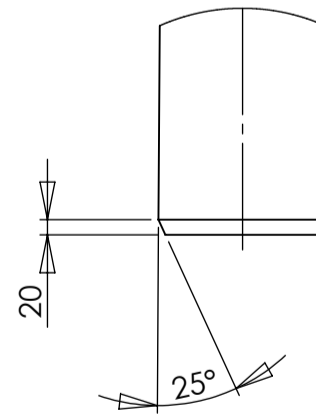

Raw Material = 200.83 kg
Area : 6.92 m²

REV	CREATED BY	DATE	DESCRIPTION	APPROVED BY	DATE
0	ta.maatta	1.6.2022	CREATE A LAYOUT	jo.innanen	1.6.2022
			Nikkarintie 4 FI-51200 Kangasniemi Finland Tel +358 15 337 7770 www.tehomet.com	THIS DRAWING IS PROPERTY OF VALMONT INDUSTRIES AND MUST NOT BE USED, COPIED OR PRODUCED WITHOUT VALMONT'S WRITTEN CONSENT SHEET : 1/1	
MATERIAL :		CUSTOMER :		CALCULATION NUMBER :	PART NUMBER :
FINISH : GALV EN ISO 1461		KH12TO27/89 4608025 KARTIOPYLVÄS ORRELLA		DRAWING NUMBER :	REVISION
GENERAL TOLERANCE ± : EN40			A3	SCALE 1:50	101020KGXS KH12TO27